

4

3

2

1

REV	Zone	DESCRIPTION	DATE	APPROVED
A		INITIAL RELEASE	03/22/2024	KG

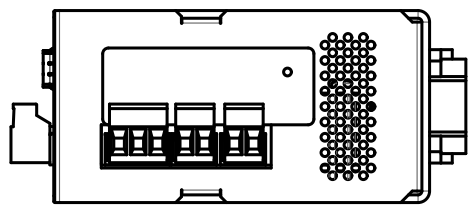
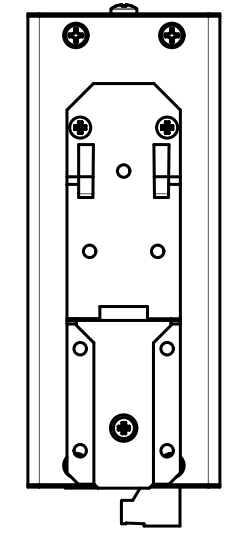
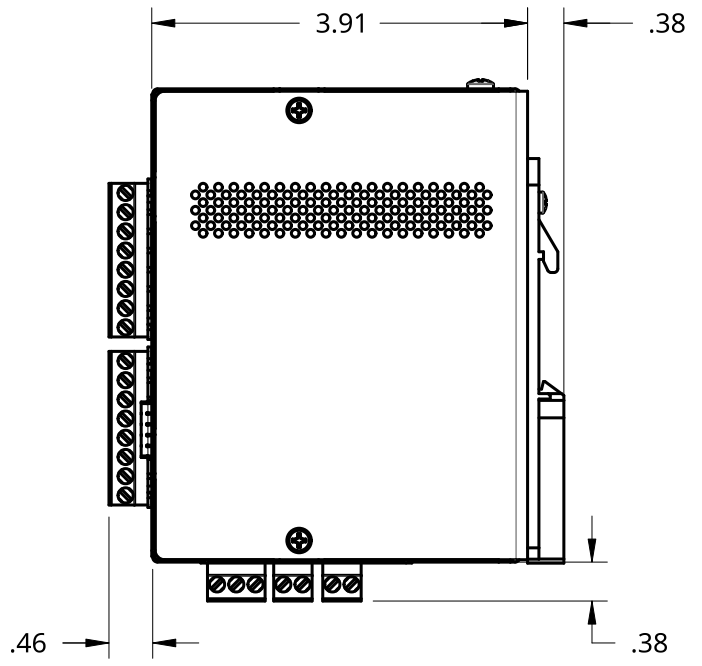
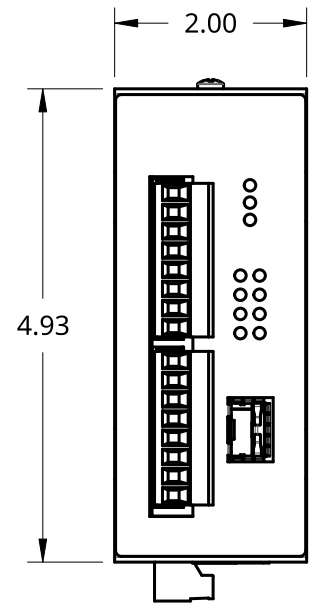
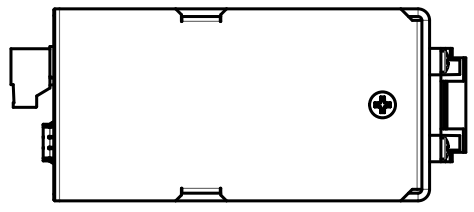
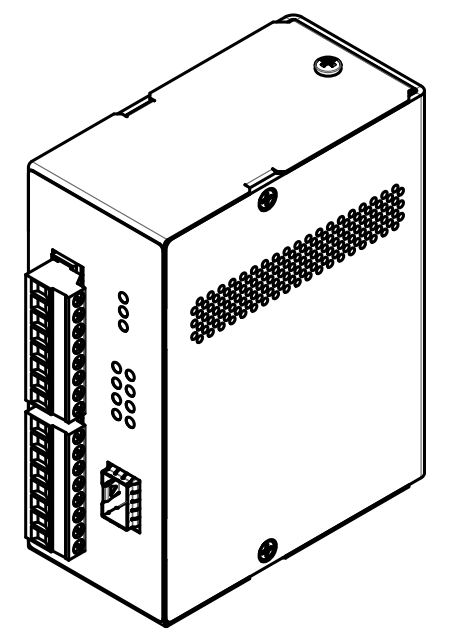

TITLE			
8CD-XX-XX-2 - 8 CHANNEL CONTACT CLOSURE SFP			
SIZE	DWG NO.	REV.	
B	AD-133	A	
SCALE	WEIGHT	SHEET	
1:2		1 of 1	



FIBEROPTICLINK

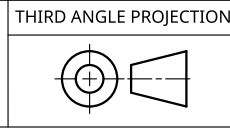

4

3

2

1

D

D

C

C

B

B

A

A