

RLH FIBERGLASS CABINETS

40"x32"x13"

30"x24"x13"

24"x24"x13"

RLH Fiberglass Cabinets

RLH Fiberglass Cabinets provide an outdoor rated dielectric enclosure for Fiber Optic Link and other telephone equipment. The Enclosures exterior surface is painted with a light gray acrylic enamel for enhanced UV protection.

Construction:

- Molded fiberglass-reinforced material has excellent temperature, chemical, and high-impact resistance
- Fiberglass is easily punched, drilled, or sawed
- Foam gasket that assures watertight and dust seal
- Drip shields are standard with each cabinet
- Hinged door with padlock latch and stop
- 3/4" plywood backboard painted gray with a fireproof paint
- Venting
- Mounting feet and hardware included
- Optional pole mounting bracket



Standard Sizes RLH Fiberglass Cabinets

Part Number	Description
8806-1282-01	24"x24"x13" Fiberglass Cabinet
8806-1284-01	30"x24"x13" Fiberglass Cabinet
8806-1286-01	40"x32"x13" Fiberglass Cabinet

**Add PMK to any cabinet part number to include an installed Pole Mount Bracket*

FIBERGLASS CABINETS
40"x32"x13"
30"x24"x13"
24"x24"x13"

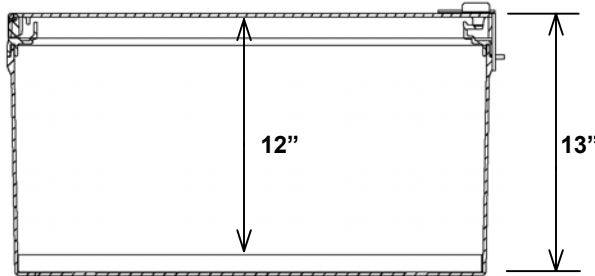
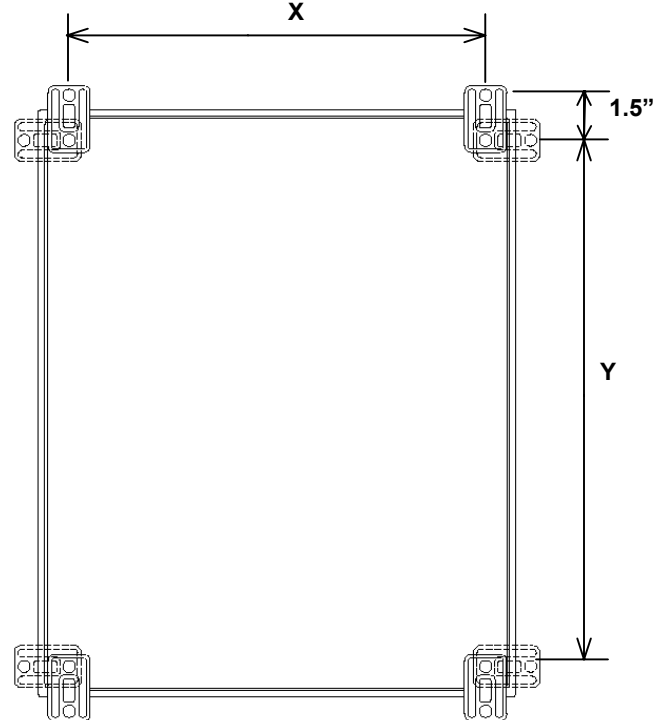
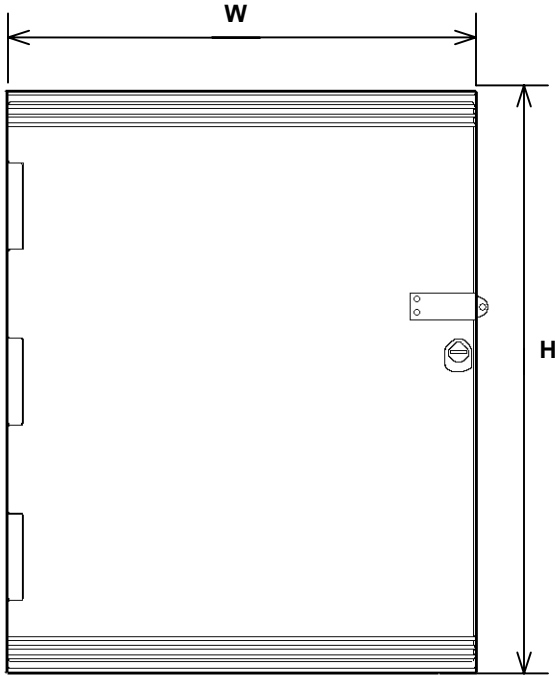

Part Number	H	W	X	Y
8806-1282-01	24.6"	24.1"	22.0"	22.5"
8806-1284-01	30.5"	24.1"	22.0"	28.3"
8806-1286-01	40.4"	32.5"	30.2"	38.1"

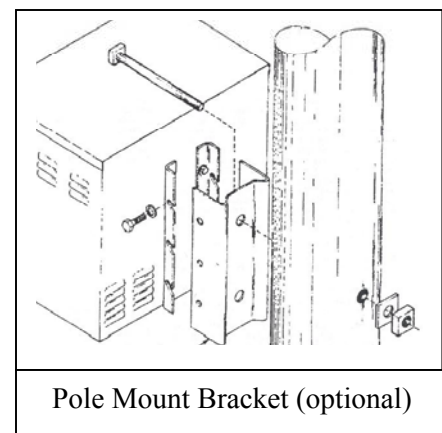

Telco Interface Units

RLH Telco Interface Units are a combination of a weatherproof cabinet and Fiber Optic Link housing pre-wired to a copper terminal. Telco Interface Units offer a n added convenience in ordering and installation. Telco Units can be made to custom specifications.

40"x32"x13" TELCO INTERFACE UNITS

8806-1288-01	5-Card Telco Interface Unit with pre-wired 10-pair copper terminal (66 type or binding post)
8806-1288-01PT	5-Card Telco Interface Unit with 10-pair pre-wired gas tube protected terminal
8806-1294-01	8-Card Telco Interface Unit with pre-wired 25-pair copper terminal (66 type or binding post)
8806-1294-01PT	8-Card Telco Interface Unit with 25-pair pre-wired gas tube protected terminal
8806-1290-01	12-Card Telco Interface Unit with pre-wired 25-pair copper terminal (66 type or binding post)
8806-1290-01PT	12-Card Telco Interface Unit with 25-pair pre-wired gas tube protected terminal

**Add PMK to any cabinet part number to include an installed Pole Mount Bracket*

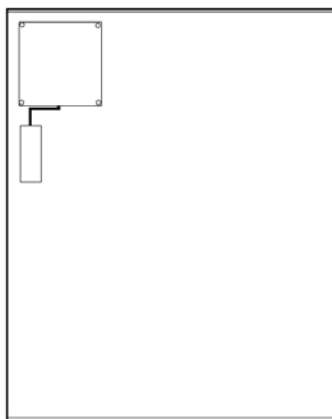

8806-1288-01

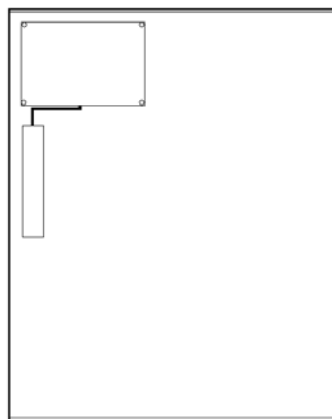

8806-1294-01

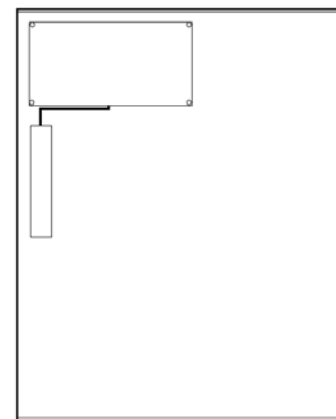

8806-1290-01

RLH Industries, Inc.
936 N. Main Street
Orange, CA 92867
Ph: (714) 532-1672, Toll-Free (866) DO-FIBER
Fx: (714) 532-1885
E-Mail: info@fiberopticlink.com
Website: www.fiberopticlink.com