

## AC/DC Wall Mount High Density Power Supply

24V, 120W ISOLATED POWER OUTPUT  
IN A WALL MOUNT CONFIGURATION

### Description

The RLH 120W AC/DC Low Density, wall mount power supply is a compact switching supply designed to convert AC or DC power (110/240VAC or 250~370VDC) to regulated 24VDC power for a wide range of industrial equipment, all mounted inside a rugged thermoplastic wall mount housing.

They include one or two 120W internal power supplies, battery charge controller and external 7AH or 20AH backup battery packs to provide uninterruptible power.

Models with dual redundant power automatically switch to the alternate internal power supply in the event of a failure, without interruption in the power delivery.

Features include convenient 12 position screw-down terminals for connecting equipment, status LEDs for quick operational assessment, and replaceable battery packs with sealed gel batteries. They have low output ripple along with short circuit, overvoltage and overload protection. AC mains cords are preinstalled, and may be easily removed for direct connection to source power.



High Density Power Supply

### Contents

Description	1
Standard Features	1
General Safety Practices	2
Installation	2
Internal Components	4
Battery Connection Diagram	5
Derating curve and static characteristics	5
Specifications	6
Ordering Information	7
Warranty	8
Technical Support	8

### Standard Features

Universal AC input range, DC input is auto sensing	Short circuit, overload, over voltage and over temperature protection
Cooling by free air convection	UL 508 (industrial control equipment) approved
LED indicator for power on, DC OK, Batt Discharge and Batt Fail	100% full load burn-in test
Fix switching frequency at 50KHz	Convenient screw down terminals accept up to 8AWG wiring
Durable, vented plastic wall mount housing with padlock hasp	Exclusive unconditional lifetime warranty

## General Safety Practices

The equipment discussed in this document may require tools designed for the activity being described. RLH recommends that service personnel be familiar with the correct handling and use of any installation equipment used, and follow all safety precautions including the use of protective personal equipment as required.

### Caution - Severe Shock Hazard

- Never install during a lightning storm or where unsafe high voltages are present.
- This equipment uses high AC and DC voltages and current, do not touch terminals when power is applied.
- Use caution when handling copper wiring and follow appropriate safety regulations.
- An external Surge Protective Device (SPD) is not required.

## Mounting Information

The power converter is intended to be wall mounted using the supplied hardware. Use a wall surface or backboard sufficiently strong enough to support the converter. This unit is not weatherproof, and must be mounted indoors or in a weather proof enclosure if used outdoors.

## Installation

Prior to installation:

- Check for shipping damage
- Check the contents to ensure correct model and powering options
- Have a clean, dry installation environment ready

Measure the voltage of the source power and ensure it is within the acceptable range to avoid damage when power is applied. Set the switch on the front of the power supplies to match the input power.

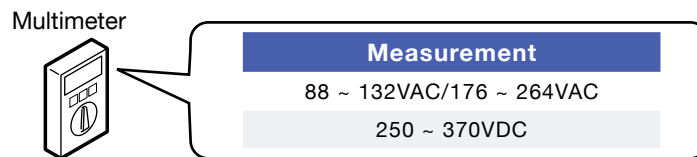

**Note:** When installing into an environment with a circuit breaker before the converter, it must be rated at 1.5 times (minimum) the output current rating of the converter. For example, use a 25A circuit breaker for a 16A output converter ( $1.5 \times 16 = 24$ ).

**Do not connect power to the converter at this point.**

### Install onto wall surface

Mount the power converter to a wall surface using the mounting holes at the top and bottom of the housing.

### Connect equipment

Connect equipment to their respective + POS and – NEG DC OUTPUT terminals.

**Note:** Always make sure the power is removed before making connections to the output terminals.

### Connect input terminals

**Turn OFF and lock out** the circuit breaker at the source panel for incoming power. Ensure that power is removed from the source wiring prior to making any connections. Output power is energized when input power is supplied and the batteries connected.

For AC power source, use the preinstalled AC cord(s) and plug them into a standard 3 prong AC power mains outlet. The AC power outlet must include a ground.

For DC input power source, remove the AC power cords and connect the primary DC source power to the AC/DC INPUT terminals at bottom of the internal power supply. Note the polarity, ensuring that the positive input wire attaches to the + positive terminal. If using redundant power modules, connect the DC inputs to both internal power supply units.

### Apply input power

**Double check all connections.** Apply power to the input wiring by turning on the source power breaker back at the panel or mains switch.

Once the AC/DC input power is applied, the output terminals are energized. Double check output power at the DC OUTPUT terminals with a multimeter.

### Connect Backup Batteries

To connect the batteries to the charge system and make them available for backup use, connect the battery to the charge unit DC battery output terminals.

**Note:** Once the battery is connected, battery output power is energized. Allow 24 hours for the batteries to achieve a full charge after connecting for the first time.

### Input / Output Terminals

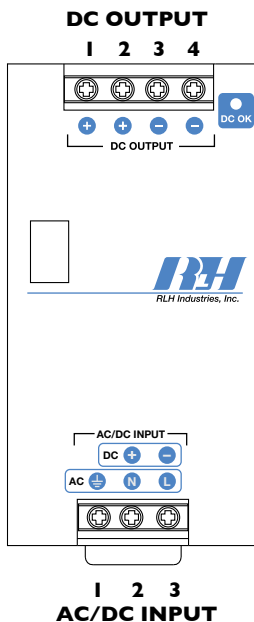

#### DC TERMINAL (OUTPUT)

No.	Description
1, 2	DC Output +V
3, 4	DC Output -V

#### AC/DC TERMINAL (INPUT)

No.	Description	
	AC	DC
1	FG ⊕	~
2	N	V+
3	L	V-

### Output Voltage Adjustment

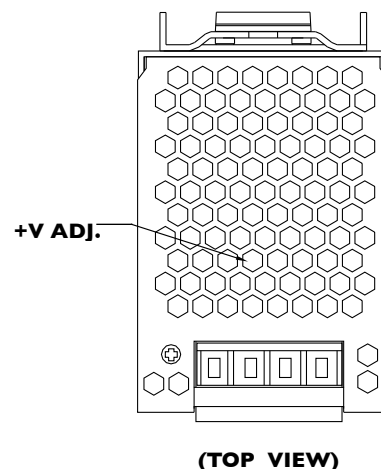

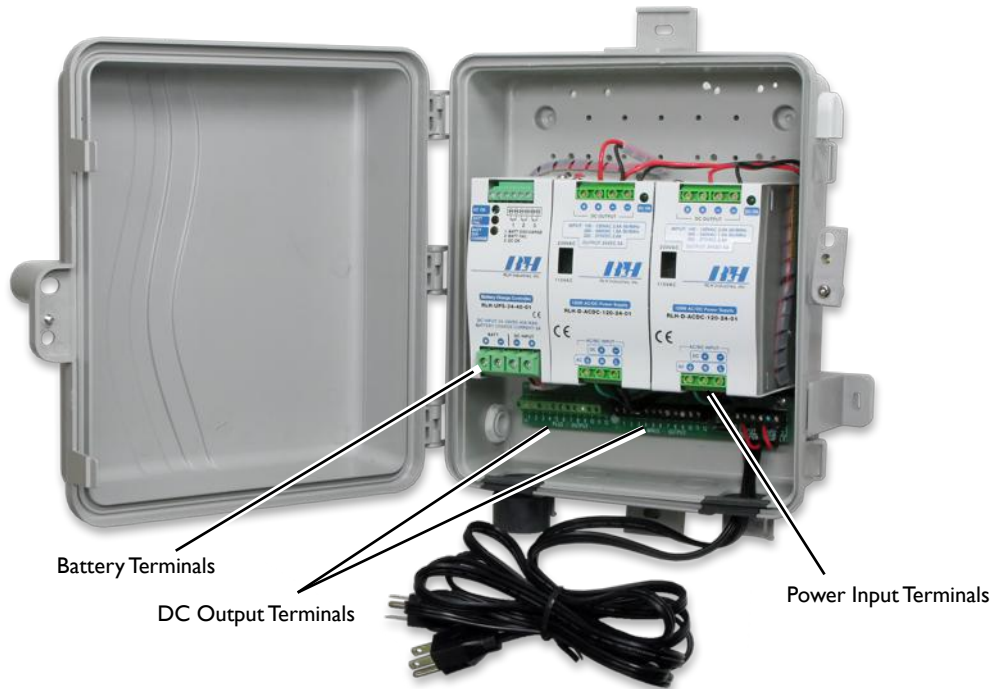

**Internal Components** - Redundant power supply model shown

**7AH Battery Pack**

**20AH Battery Pack**



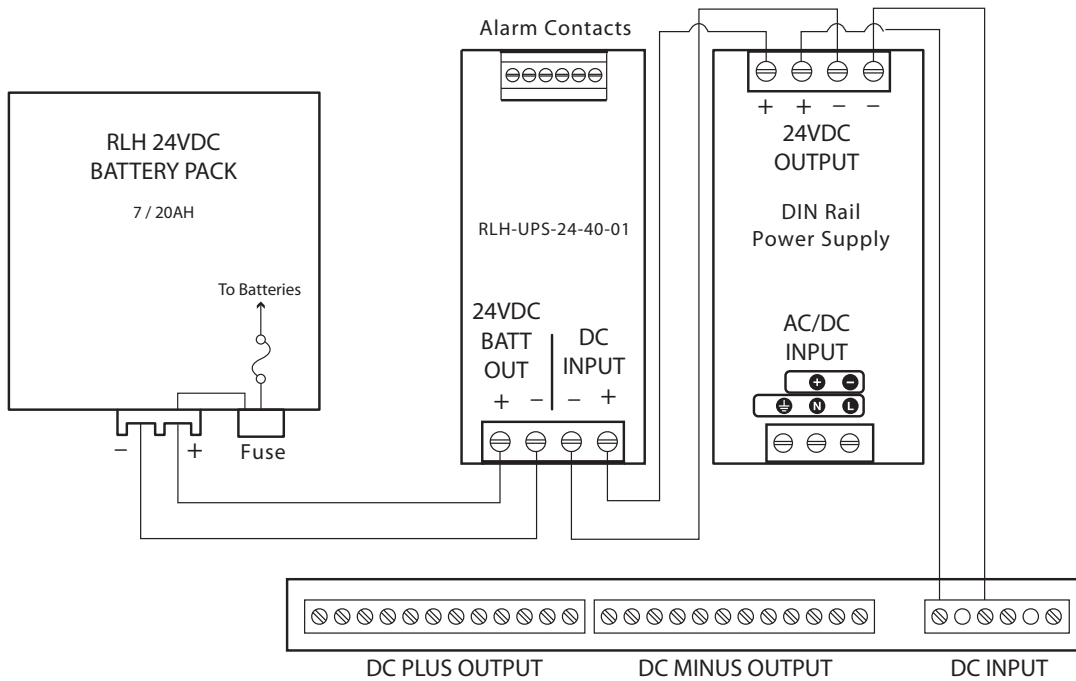

**Battery Pack Connection Diagram**

**Derating Curve**

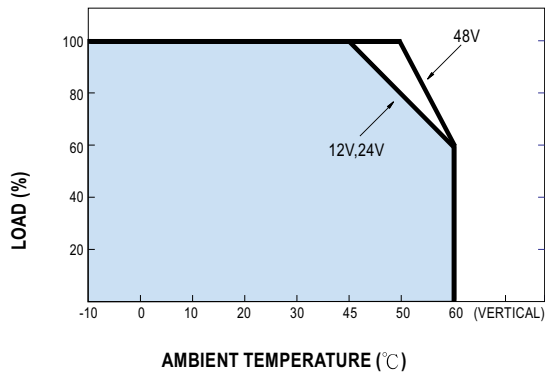

**Static Characteristics (24V)**

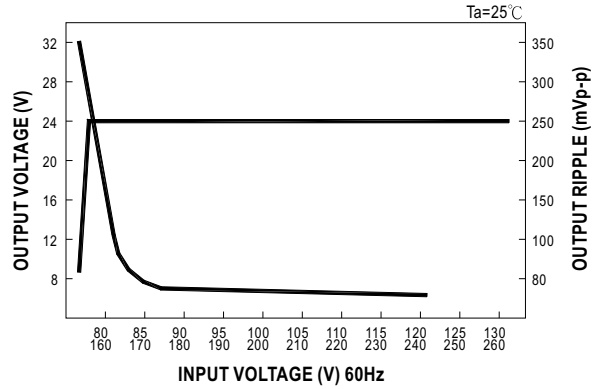

**Derating curve and static characteristics**

Specifications subject to change without notice.

## Specifications

<b>DC OUTPUT</b>	DC VOLTAGE	24V
	RATED CURRENT	5A
	CURRENT RANGE	0 ~ 5A
	RATED POWER	120W
	RIPPLE & NOISE (max.) Note 2	80mVp-p
	VOLTAGE ADJ. RANGE	24 ~ 28V
	VOLTAGE TOLERANCE Note 3	±1.0%
	LINE REGULATION	±0.5%
	LOAD REGULATION	±1%
	SETUP, RISE TIME	500ms, 70ms/230VAC, 500ms, 70ms/115VAC at full load
	HOLD UP TIME (Typ.)	36ms/230VAC, 32ms/115VAC at full load
<b>INPUT</b>	VOLTAGE RANGE	88 ~ 132VAC/176 ~ 264VAC by switch, 248 ~ 370VDC
	FREQUENCY RANGE	47 ~ 63Hz
	EFFICIENCY (Typ.)	84%
	AC CURRENT (Typ.)	2.6A/115VAC, 1.6A/230VAC
	INRUSH CURRENT (Typ.)	Cold Start 20A/115VAC, 40A/230VAC
	LEAKAGE CURRENT	<3.5mA / 240VAC
<b>PROTECTION</b>	OVERLOAD	105 ~ 150% rated output power Protection type : Constant current limiting, recovers automatically after fault condition is removed
	OVER VOLTAGE	29 ~ 33V Protection type : Shut down o/p voltage, re-power on to recover
	OVER TEMPERATURE	90°C ±5°C (TSW1) Protection type : Shut down o/p voltage, recovers automatically after temperature goes down
<b>ENVIRON- MENT</b>	WORKING TEMP.	-10°C~ +60°C (Refer to output load derating curve)
	WORKING HUMIDITY	20 ~ 90% RH non-condensing
	STORAGE TEMP., HUMIDITY	-20°C ~ +85°C, 10 ~ 95% RH
	TEMP. COEFFICIENT	±0.03%/°C (0 ~ 50°C)
<b>BATTERY PACK</b>	CAPACITY	24VDC 7.2AH 24VDC 20AH
	FUSE RATING	6A
	DIMENSIONS	7.2AH: H8.25in. x W8.25in. x D4.5in. (216mm x 216mm x 114mm) 20AH: H8.25in. x W8.25in. x D7.5in. (216mm x 216mm x 191mm)
	MOUNTING SYTLE	Wall Mount
	HOUSING	Molded Thermoplastic
	BATTERY TYPE	Sealed, rechargeable, no-spill gel type battery, user replaceable
	BATTERIES PER UNIT	2 each

Specifications subject to change without notice.

## Specifications

<b>SAFETY &amp; EMC</b>	SAFETY STANDARDS	UL508, UL60950-1, TUV EN60950-1 approved
	WITHSTAND VOLTAGE	I/P-O/P:3KVAC I/P-FG:1.5KVAC O/P-FG:0.5KVAC
	ISOLATION RESISTANCE	I/P-O/P, I/P-FG, O/P-FG:100M Ohms/500VDC
	EMI CONDUCTION & RADIATION	Compliance to EN55011,EN55022 (CISPR22) Class B
	HARMONIC CURRENT	Compliance to EN61000-3-2,-3
	EMS IMMUNITY	Compliance to EN61000-4-2,3,4,5,6,8,11, ENV50204, EN55024, EN61000-6-2 (EN50082-2), heavy industry level, criteria A
<b>OTHER</b>	MTBF	136.8Khrs min. MIL-HDBK-217F (25°C)
	POWER SUPPLY HOUSING DIMENSIONS	W11.4" x H13.4" x D4.5" Including mounting tabs
	RECOMMENDED INPUT CIRCUIT BREAKER	1.5 X Input Rating
	NOTE	<ol style="list-style-type: none"> <li>All parameters NOT specially mentioned are measured at 230VAC input, rated load and 25°C of ambient temperature.</li> <li>Ripple &amp; noise are measured at 20MHz of bandwidth by using a 12" twisted pair-wire terminated with a 0.1uf &amp; 47uf parallel capacitor.</li> <li>Tolerance : includes set up tolerance, line regulation and load regulation.</li> <li>The power supply is considered a component which will be installed into a final equipment. The final equipment must be re-confirmed that it still meets EMC directives.</li> </ol>

Specifications subject to change without notice.

## Ordering Information

Part Number	Input	Output	Current	Redundant Power	Battery Backup	Replacement Battery Pack
8806-1206-03D	110-240AC/250-350VDC	24VDC	4A	N/A	7AH	8806-1206-03BP
(CLEI: NPPSRV0CRA)						
8806-1206-03D2	110-240AC/120-330VDC	24VDC	4A	Included	7AH	8806-1206-03BP
8806-1206-03D-20	110-240AC/250-350VDC	24VDC	4A	N/A	20AH	8806-1250-06BP
8806-1206-03D2-20	110-240AC/120-330VDC	24VDC	4A	Included	20AH	8806-1250-06BP
8806-1203-04D-NB	110-240AC/250-350VDC	24VDC	4A	N/A	N/A	N/A
8806-1203-04D2-NB	110-240AC/120-330VDC	24VDC	4A	Included	N/A	N/A

## Warranty

RLH is recognized throughout the U.S. and offers the only **UNCONDITIONAL LIFETIME WARRANTY** in the industry. We are very proud of our warranty which simply states that the product is warranted to be free of defects in material and workmanship for the **LIFE OF THE PRODUCT**. Batteries carry a 5- year unconditional warranty.

- We believe our customers shouldn't have to incur additional costs due to failure or damage
- We engineer our products with total confidence in our quality
- We understand how safety and reliability impact the total cost of ownership
- We know that customer support extends beyond the initial sale, so **we stand behind our products**

RLH will replace any product, or part thereof, that fails **FOR ANY REASON**, provided the defective part is returned to RLH Freight prepaid. This warranty is **UNCONDITIONAL** and valid even when RLH products have been abused or mishandled, or the product has been damaged as a result of a natural disaster. This warranty will reduce your costs and simplify your maintenance activities. Not all RLH products are covered by this warranty.

**To make a warranty claim, or schedule repair or replacement of your RLH product, please contact us for an RMA number.** You will be promptly assisted by one of our warranty specialists. All returns must have an RMA number before we can receive any items.

## Technical Support

<b>Normal technical support:</b> (Mon - Fri 6am - 6pm PST)	Local (714) 532-1672 Toll Free (800) 877-1672 Toll Free (866) DO-FIBER
<b>24/7 Technical support:</b>	(714) 366-2503 (714) 457-5740

## Contact Information

<b>Corporate Headquarters:</b>	RLH Industries, Inc. 936 N. Main Street Orange, CA 92867 USA
<b>Phone:</b>	Local (714) 532-1672 Toll Free (800) 877-1672 Toll Free (866) DO-FIBER
<b>Fax:</b>	(714) 532-1885
<b>Email:</b>	info@fiberopticlink.com
<b>Web site:</b>	www.fiberopticlink.com



RLH Industries, Inc.  
936 N. Main Street, Orange, CA 92867 USA  
T: (714) 532-1672  
F: (714) 532-1885

Please contact your RLH sales representative for pricing and delivery information.

Specifications subject to change without notice.